

RELACIONAMENTO

ACO	N	DIAM	QUANT	CUNTA	C.TOTAL
CA50	1	4,2	248	155	38440
CA50	3	8,0	71	631	22922
CA50	4	8,0	2	86	1422
CA50	5	8,0	6	589	1422
CA50	7	8,0	16	226	7172
CA50	8	8,0	4	206	3818
CA50	9	14,0	2	159	3036
CA50	10	16,0	2	159	3172
CA50	11	18,0	2	159	1952
CA50	13	18,0	2	288	738
RESUMO DO AÇO			233		
CA50	8,0				68,7
CA50	14,0				72,4
CA50	16,0				72,4
PESO TOTAL					72,4
CA50	233				72,4
CA50	72,4				72,4

Volume de concreto (C-25) = 5,22 m³
Área de forma = 30,19 m²

RELACIONAMENTO

ACO	N	DIAM	QUANT	CUNTA	PESO + 10%
CA50	1	4,2	248	155	118
CA50	3	8,0	71	631	148
CA50	4	8,0	2	86	118
CA50	5	8,0	6	589	148
CA50	7	8,0	16	226	104
CA50	8	8,0	4	206	104
CA50	9	14,0	2	159	1278
CA50	10	16,0	2	159	1278
CA50	11	18,0	2	159	889
CA50	13	18,0	2	288	1278
RESUMO DO AÇO					
CA50	8,0				43,7
CA50	14,0				45,1
PESO TOTAL					54,8
CA50	18,7				54,8
CA50	54,8				54,8

Volume de concreto (C-25) = 5,22 m³
Área de forma = 35,23 m²

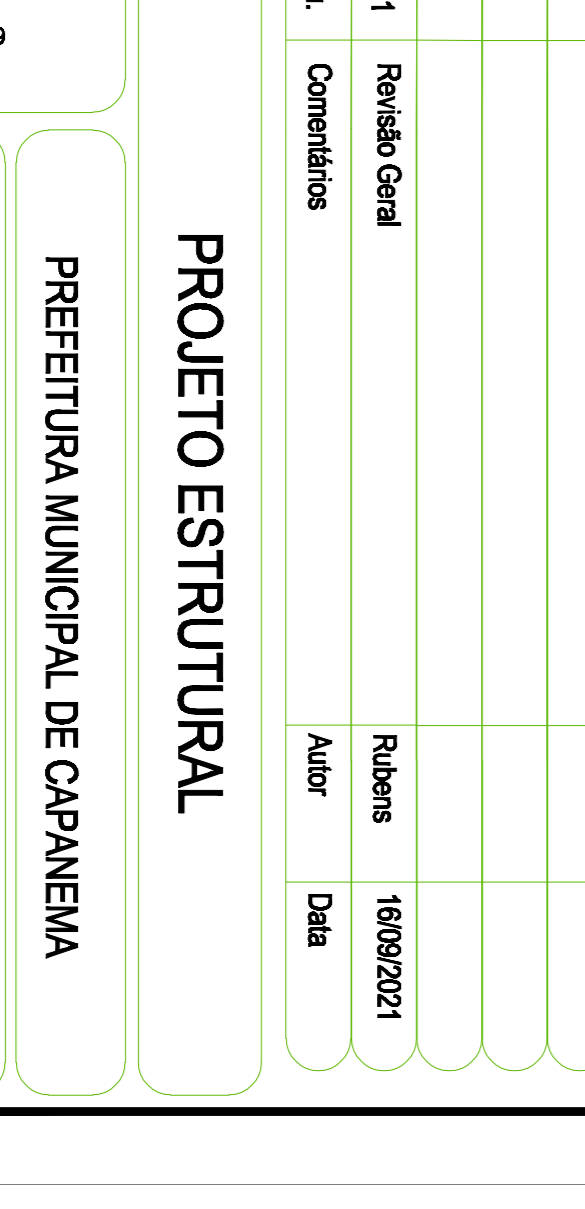
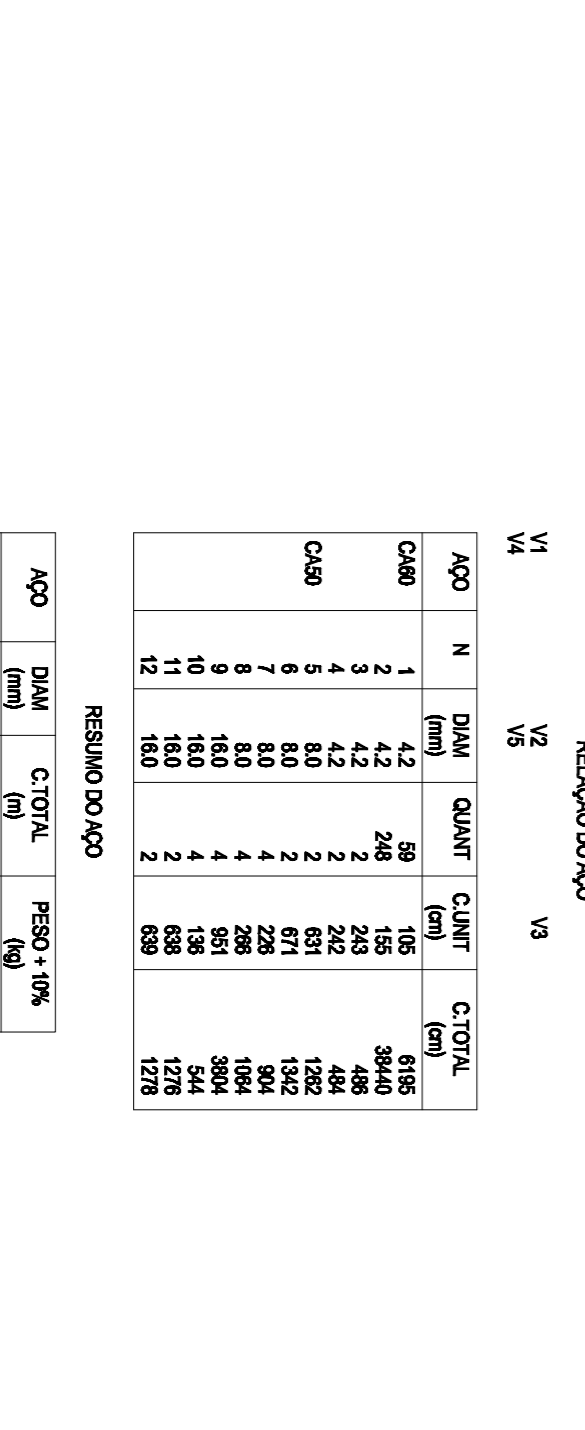
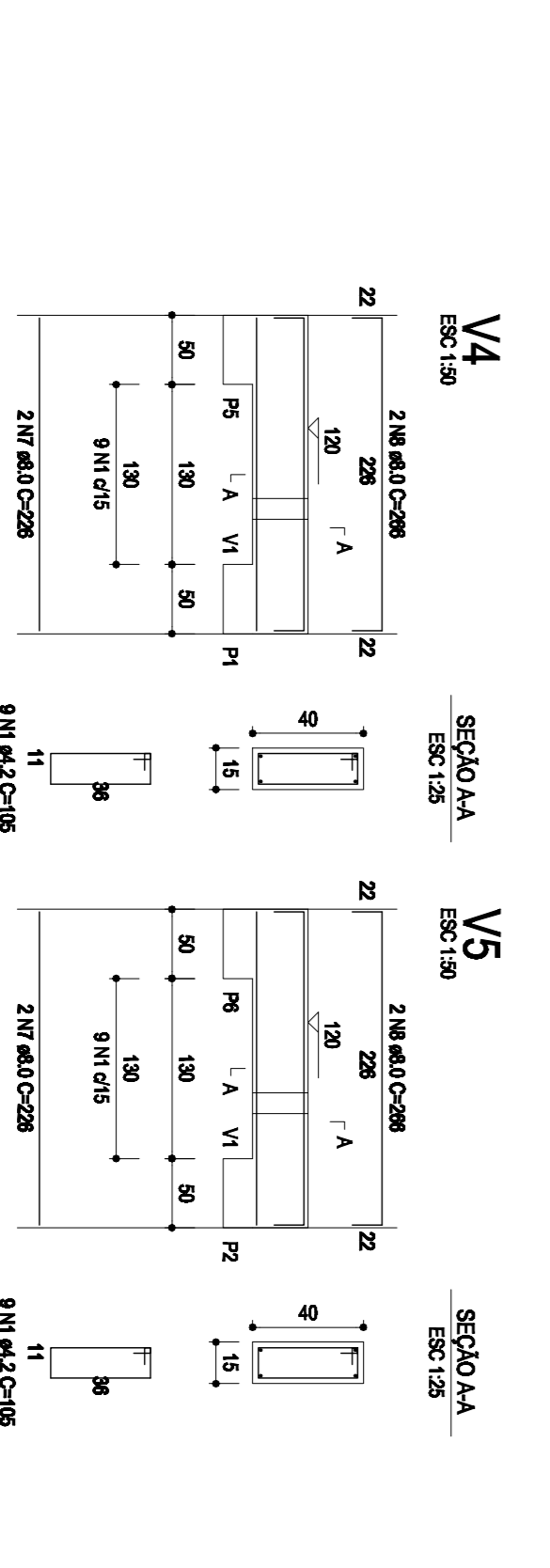
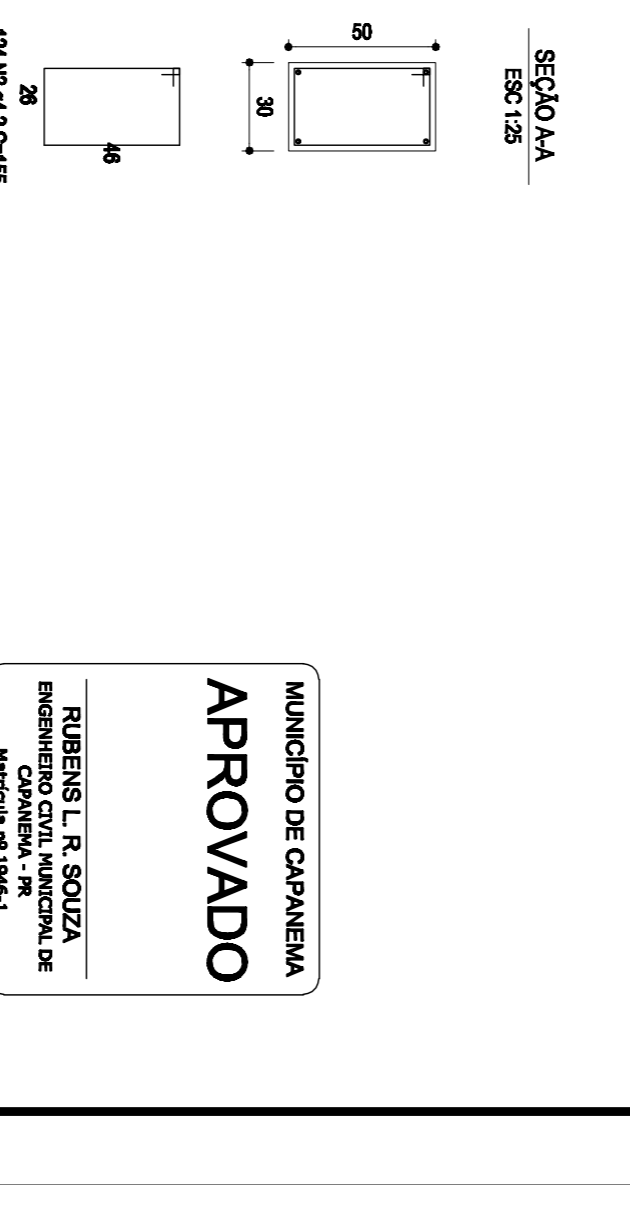
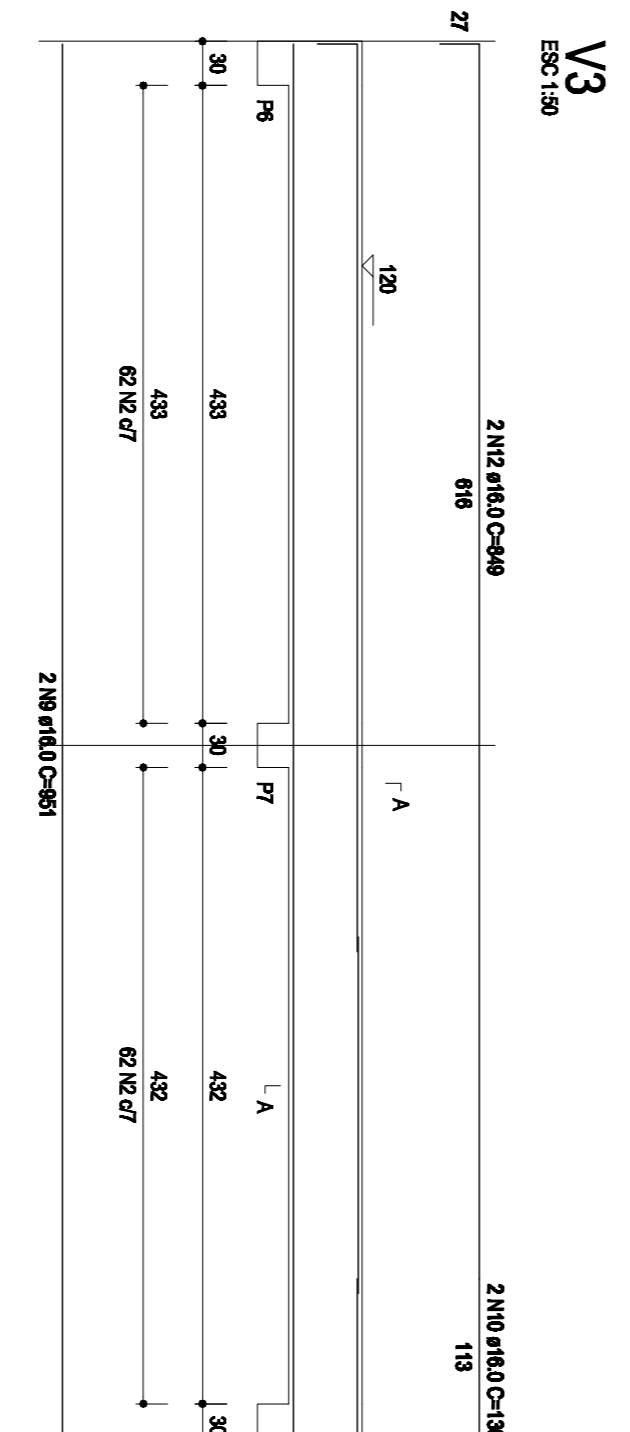
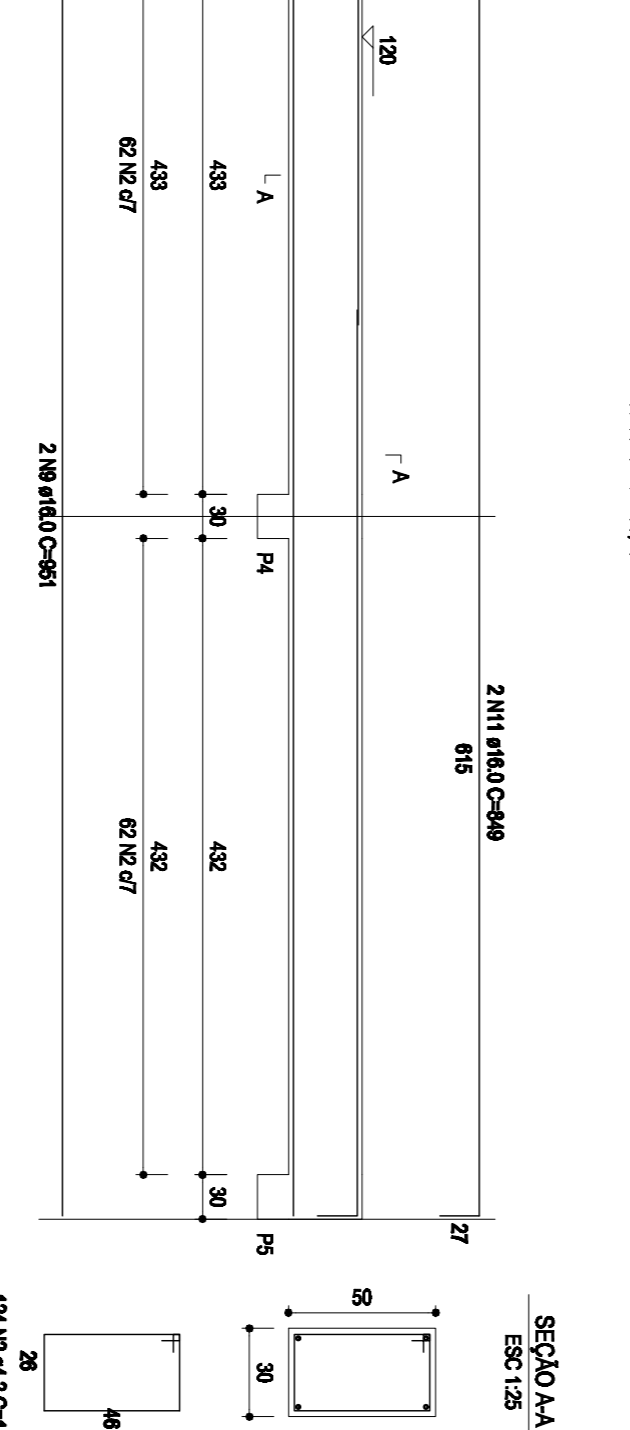
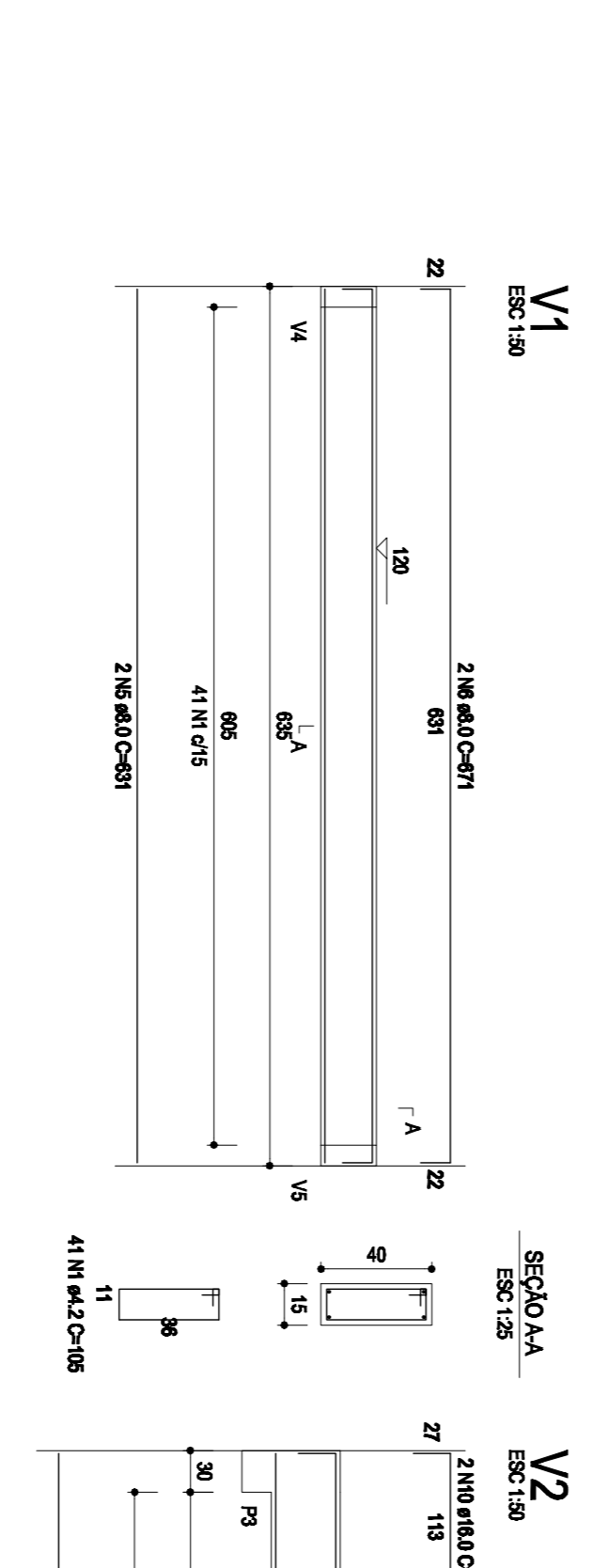

MUNICÍPIO DE CAPANEMA
APROVADO
RUBENS L. R. SOUZA
ENGENHEIRO CIVIL DE
CAPANEMA - PR
HABILITADO Nº 1946-1

Revisões da Prancha

Nº	Comentários	Data
001	Revisão Geral	16/09/2021

PROJETO ESTRUTURAL
PREFEITURA MUNICIPAL DE CAPANEMA
ARQUIBANCADA DA QUADRA DE AREIA NO GINÁSIO DE ESPORTES
DETALHE VIGAS BALDRAME E VIGAS COTA 1,20M

RUBENS L. R. SOUZA
Rua Dr. Luiz Oscar Prauchner 1079
Planalto-PR (046)35561186
rubensluis@globomail.com

Chataras nº 62-83 e 79 no Bairro Santo Expedito no Gásio de Esportes
Desenho: Eng Rubens
Data: 16/09/2021

Área: 94,25 m²
Unidade: cm

Escala: **01/50**
Página: **03/05**